

CLETOP Replacement Tape User's Manual

This product is the replacement tape for the optical connector cleaner (CLETOP). Please read this manual carefully and follow its instructions.



Prohibited

- Do NOT store in direct sunlight, and avoid hot and/or humid environments as the product may become deformed.
- Do NOT disassemble this product.
- Do NOT touch the tape (cleaning cloth). The quality will deteriorate.
- Do NOT use for any purpose which has not been described in this manual. Products may be damaged.
- Please consign this product to a properly licensed waste management operator.

Composition of the product

This product consists of a pair of the transparent reel and the red reel which the new tape (cleaning cloth) wound on.

Parts

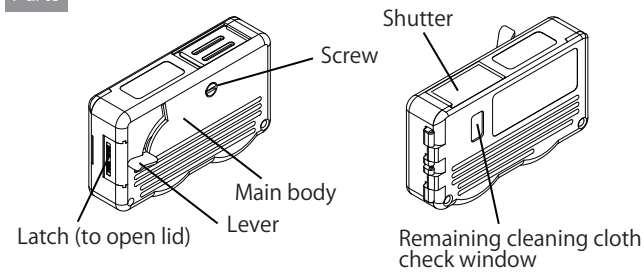

Instructions

① Unscrew the screw located on the face of the case by turning it counter-clockwise. The screw cannot be totally withdrawn because a stopper inserted on the inside of the body.

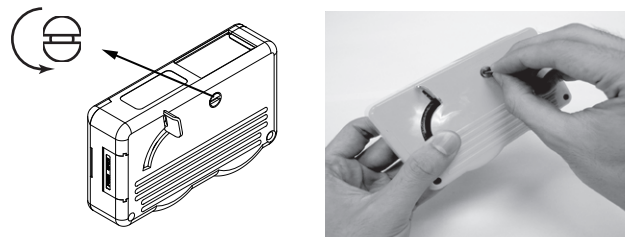

② To open the lid of the main body, pull the latch on the side of the main body while simultaneously depressing the latch.

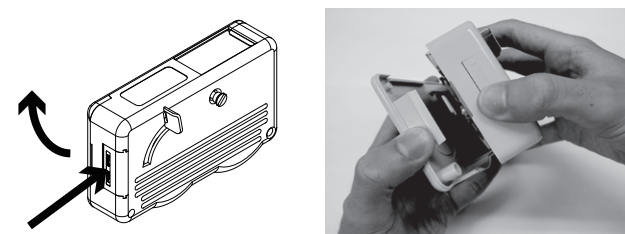

③ Remove the red reel, used tape with the transparent reel and the rubber unit.

NOTE: Dispose the red reel and the used tape with transparent reel. In addition, please do not throw away the rubber unit because you shall use again it.

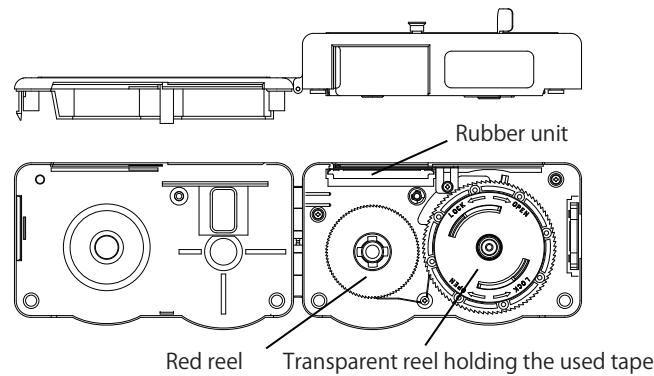

Turn the transparent reel in the OPEN direction in order to unlock while pressing the sawtoothed parts of the red reel with one hand, and pull out it. Please see the following figures for the position of the transparent reel and the sawtoothed parts.

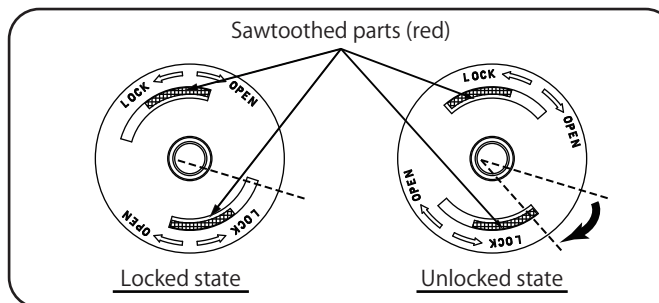

④ Fix the new tape to the transparent reel using the piece of adhesive tape on the cloth.

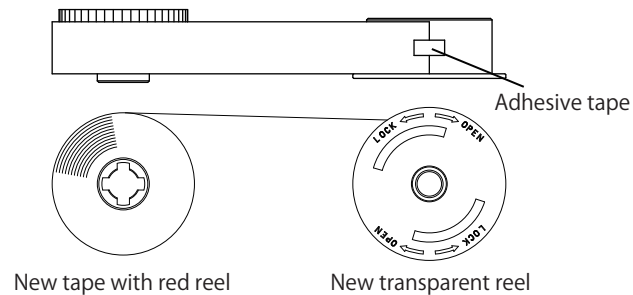

⑤ Set a new tape with the red reel and transparent reel.

For the set of a new tape with the red reel, engage the pawl with the reel gear while turning clockwise. For the set of a transparent reel, fit the two projections on the transparent reel into the corresponding grooves on the red wheel, and turn the reel slightly in the LOCK direction.

Be sure to put the tape through the two rollers, as indicated.

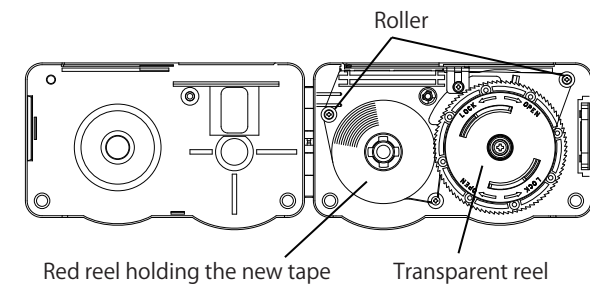

NOTE: Turn the lever a few times to remove the slack on the tape.

⑥ Set the rubber unit into the case.

NOTE: Convex portion shall be on the bottom.

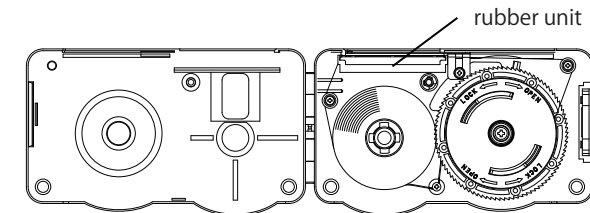

⑦ Close the main body and turn the screw clockwise to tighten the lid.

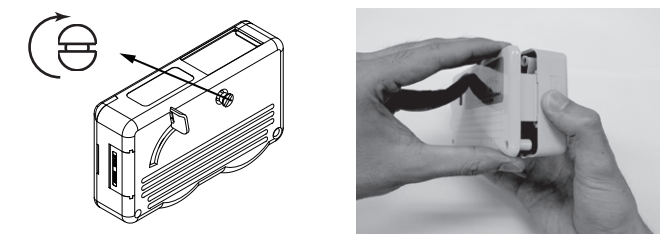

⑧ Turn the lever a few times to confirm that the tape is being wound correctly.

* CLETOP is a trademark of NTT Advanced Technology Corporation.

Inquiries

NTT Advanced Technology Corporation

http://www.ntt-at.com/product/optical_cleaner/

